

FOBA SUPERBALL® M-Line: The small ball head that delivers high performance...

The M-Line is the «Light weight» of the SUPERBALL family. Lasting precision and functionality mark the key features of these two new ball heads (the BENTO and the BENTA). The heads guarantee optimum stability, ergonomic operation and maximum clamping force and are designed to withstand many years of use under harsh everyday conditions. The FOBA SUPERBALL® M-Line is ideal for 35mm SLR and medium-format cameras and ensures both precise camera movement and reliable locking.



SUPERBALL® M-1 (BENTA)
including camera plate with 1/4" thread
For 35 mm and medium-format cameras. Multifunction locking system, High clamping force (4,5 kg for a lever length of 300 mm), full 360° panoramic rotation, holds up to 8 kg, 3/8" and 1/4" thread adapter

Height	90 mm
Weight	275 g

SUPERBALL® M-1 (BENTO)
with quick-release unit. Same product features and specifications as BENTA

Height	110 mm
Weight	405 g



Because of the hollow spaces inside of the housing the M-1 tripod heads are very much light weight.

FOBA®
STUDIO-TECHNOLOGY

FOBA®
STUDIO-TECHNOLOGY

PHOTAL

sinar broncolor FOBA

www.photal.nl

PHOTAL BV
Edisonstraat 31
6604 BT Wijchen
telefoon 024-642 03 34
telefax 024-642 14 53
info@photal.nl

We reserve the right to make technical changes without notice. ©03

FOBA tripod heads

hellerwerbung.ch

The comprehensive
FOBA range:

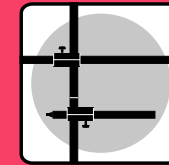

FOBA COMBITUBE System
FOBA COMBIROHR System
Système de tubes FOBA

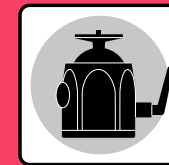

FOBA tripod heads
FOBA Stativköpfe
FOBA têtes de trépieds

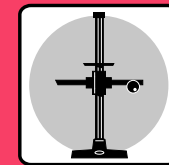

Studiostands, Tripods
Stativ
Pied à colonne, Trépied

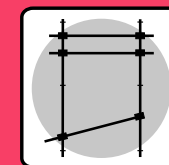

Deckenschienen-Systeme
Systèmes de rails
Roof track systems

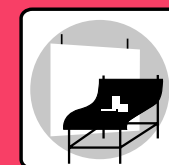

Background tables
Aufnahmische
Tables de pris de vue



FOBA tripod heads. The camera-tripod safety link.

FOBA®
STUDIO-TECHNOLOGY

FOBA tripod heads – quality made in Switzerland.

Among a wide range of professional studio equipment for photographers, the Swiss company FOBA supplies six different tripod heads offering optimal stability, ergonomics and safety. FOBA TILTING HEADS are built for the heaviest cameras up to 8x10" format, allowing precise positioning and secure locking. The FOBA SUPERBALL head is the most popular of the FOBA range. With its elegant design and sturdy construction, this head is ideal for all cameras. The smaller FOBA MINI SUPERBALL is the perfect tripod mounting for small and medium format cameras.

Both the FOBA SUPERBALL and MINI SUPERBALL are available either with camera plate or quick-release unit.



FOBA SUPERBALL: for medium and large-format cameras



The FOBA SUPERBALL (BALLA) with quick-release mounting offers maximum convenience and optimal security. A wide variety of camera plates is available, all of which can remain on the camera.

Diameter:	76 mm
Height:	130 mm
Weight:	1380 g



Camera plate with 1/4" and 3/8" threads (BALPO). Fixed to FOBA SUPERBALL with two Phillips screws.

Weight: 50 g



Quick-release mounting (BALSO) for FOBA SUPERBALL. Takes various quick-release plates. With removable safety plug.

Weight: 120 g



The FOBA SUPERBALL (BALLO) with its advanced technology is one of the most popular tripods among professional photographers. Reversible camera plate, threaded 1/4" and 3/8".

Diameter:	76 mm
Height:	130 mm
Weight:	1300 g



Panorama plate (BALTO) for installation between camera mounting and FOBA SUPERBALL. Full 360° rotation, calibrated in degrees, with clamping screw.

Diameter:	76 mm
Weight:	250 g

FOBA MINI SUPERBALL: for medium and small-format cameras



The FOBA MINI SUPERBALL (BALLI) has the same technology as the FOBA SUPERBALL in a smaller version. Interchangeable camera plate with 1/4" and 3/8" mounting screws. Large high-precision spherical head, friction clamp and fixing knob.

Diameter:	63 mm
Height:	110 mm
Weight:	580 g



MINI SUPERBALL PLUS (BALMI) with camera plate and panoramic adapter.

Diameter:	65 mm
Height:	115 mm
Weight:	740 g
Load:	8 kg



Panorama adapter for MINI SUPERBALL PLUS (BALTA)

Weight: 230 g



Quick-release unit (BALSI) for FOBA MINI SUPERBALL, with removable safety plug. Takes various quick-release plates.

Weight: 120 g



FOBA MINI SUPERBALL (BALLU) with well-tried FOBA quick-release unit for various camera plates (Hasselblad, Mamiya, small-format cameras) or 1/4" and 3/8" threads. The quick-release unit has a removable safety plug to prevent the camera sliding off.

Diameter:	63 mm
Height:	105 mm
Weight:	620 g



MINI SUPERBALL PLUS (BALMU) with quick-release unit and panoramic adapter.

Diameter:	65 mm
Height:	120 mm
Weight:	820 g
Load:	8 kg

The following accessories are available for the FOBA SUPERBALL and FOBA MINI SUPERBALL:

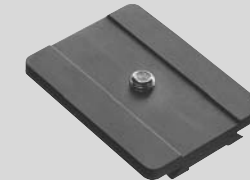

Quick-release plate with 3/8" thread (BALPU).

Weight: 110 g

Quick-release plate with 1/4" thread (BALPI).

Weight: 110 g

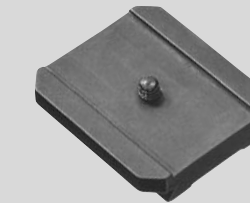

Quick-release plate with Hasselblad mounting and 1/4" thread (BALTE).

Weight: 90 g



Quick-release plate with Hasselblad mounting and 3/8" thread (BALPE).

Weight: 90 g

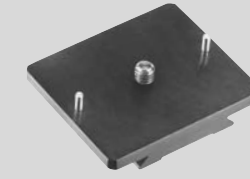

Quick-release plate with Mamiya mounting and 1/4" thread (BALMA).

Weight: 60 g

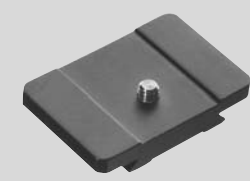

Short quick-release plate with small-format camera mounting and 1/4" thread (BALPA).

Weight: 55 g



Camera plate with 1/4" and 3/8" threads (BALMO). Fixes to FOBA MINI-SUPERBALL with two screws.

Weight: 50 g



FOBA DUAL TILTING HEAD (ASMA) with two tilt axes through over 90° and panorama plate mounted on needle bearings. The tilting axes are effortlessly fixed by powerful eccentric clamp. For use with 3/8" or 1/4" tripod screws.

Weight: 1750 g



Quick release unit (BALSU) incl. SLR-plate. With shifting device and removable security stopper. Takes various quick-release plates. Fits all tripod heads.

Weight: 175 g



Clamp for clamping tripod (ASNEA).

Weight: 670 g



Camera mounting for clamping tripod (ASNAO).

Weight: 450 g



FOBA TILTING HEAD (ASMIO) with one tilt axis through over 90° and panorama plate mounted on needle bearings. The tilting axis is effortlessly fixed by powerful eccentric clamp. For use with 3/8" or 1/4" tripod screws.

Weight: 1150 g



Baseplate (BALGO) for mounting FOBA tripod heads on floor or tabletop.

Weight: 900 g

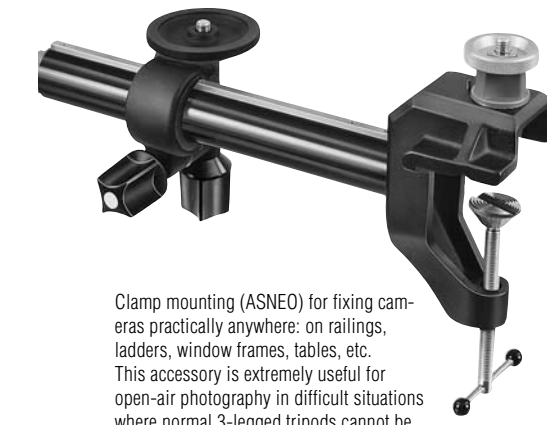

Clamp mounting (ASNEO) for fixing cameras practically anywhere: on railings, ladders, window frames, tables, etc. This accessory is extremely useful for open-air photography in difficult situations where normal 3-legged tripods cannot be used. The ASNEA clamp and ASNAO camera mounting are also available separately.

Weight complete: 1450 g

